

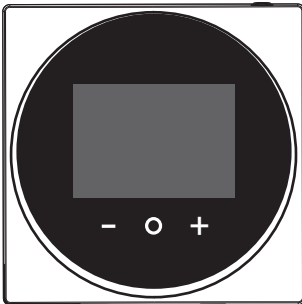

Installation and operation manual

Wired remote controller



BRC1H51W
BRC1H51K
BRC1H51S

Installation and operation manual
Wired remote controller

English

(GB) Product page: www.daikin.eu/BRC1H

For the original declaration of conformity and the latest version of this manual, see the product page above. Hereby, Daikin Europe N.V. declares that the radio equipment type BRC1H is in compliance with the Directive 2014/53/EU.

(D) Produkt-Seite: www.daikin.eu/BRC1H

Um die Konformitätserklärung im Original und die jüngste Version dieses Handbuchs einzusehen, siehe die oben angegebene Produkt-Seite.

Hiermit erklärt Daikin Europe N.V., dass der Funk-Gerätetyp BRC1H der Richtlinie 2014/53/EU entspricht.

(F) Page produit: www.daikin.eu/BRC1H

Pour la déclaration de conformité originale et la dernière version de ce manuel, voir la page produit ci-dessus.

Par la présente, Daikin Europe S.A. déclare que l'équipement radio de type BRC1H est conforme à la Directive 2014/53/EU.

(NL) Productpagina: www.daikin.eu/BRC1H

Voor de oorspronkelijke conformiteitsverklaring en de nieuwste versie van deze handleiding, zie de productpagina hierboven.

Hierbij verklaart Daikin Europe N.V. dat de radioapparatuur van het type BRC1H conform de Richtlijn 2014/53/EU is.

(E) Página del producto: www.daikin.eu/BRC1H

Para conocer la declaración de conformidad original y la versión más reciente de este manual, consulte la página del producto arriba.

Por la presente, Daikin Europe N.V. declara que el equipo de radio BRC1H cumple con la Directiva 2014/53/EU.

(I) Pagina prodotto: www.daikin.eu/BRC1H

Per consultare la dichiarazione di conformità originale e l'ultima versione del presente manuale, vedere la pagina prodotto sopra indicata.

Con la presente, Daikin Europe N.V. dichiara che l'apparecchiatura radio di tipo BRC1H è conforme ai requisiti della direttiva 2014/53/UE.

(GR) Σελίδα προϊόντος: www.daikin.eu/BRC1H

Για την αρχική δήλωση συμμόρφωσης και την τελευταία έκδοση αυτού του εγχειριδίου, ανατρέξτε στην παραπάνω σελίδα του προϊόντος.

Δια του παρούσης, η Daikin Europe N.V. δηλώνει ότι η συσκευή BRC1H, τύπου ραδιοεξοπλισμού, συμμορφώνεται με την Οδηγία 2014/53/ΕΕ.

(P) Página do produto: www.daikin.eu/BRC1H

Consulte a declaração de conformidade original e a versão mais recente deste manual na página do produto acima.

A Daikin Europe N.V. declara que o equipamento de rádio do tipo BRC1H está em conformidade com a directiva 2014/53/EU.

(RUS) Информация об оборудовании: www.daikin.eu/BRC1H

Оригинальный текст заявления о соответствии и самое свежее издание этого руководства см. на указанной выше странице с информацией об оборудовании.

Компания Daikin Europe N.V. настоящим заявляет, что радиооборудование типа BRC1H соответствует требованиям Директивы 2014/53/EU.

(TR) Ürün sayfası: www.daikin.eu/BRC1H

Orijinal uygunluk beyanı ve bu kılavuzun son sürümü için yukarıdaki ürün sayfasına bakın.

Burada Daikin Europe N.V., BRC1H tipi radyo ekipmanının 2014/53/EU Direktifi ile uyumlu olduğunu beyan eder.



Table of Contents

1	General safety precautions	3
1.1	For the user	3
1.2	For the installer	3
2	About this document	4
For the user 4		
3	Buttons	4
4	Home screens	4
5	Status icons	5
6	Operation	5
6.1	Operation mode	5
6.1.1	To set the operation mode	5
6.2	Setpoint	6
6.2.1	To set the setpoint	6
6.3	Airflow	6
6.3.1	Airflow direction	6
6.3.2	Airflow level	6
6.4	Ventilation	6
6.4.1	Ventilation mode	6
6.4.2	Ventilation rate	7
6.5	Advanced operation	7
6.5.1	To make a Bluetooth connection	7
7	Maintenance and service	7
7.1	Overview: Maintenance	7
For the installer 7		
8	About the box	7
8.1	To unpack the controller	7
9	Preparation	8
9.1	Wiring requirements	8
10	Installation	8
10.1	Mounting the controller	8
10.1.1	To mount the controller	8
10.2	Connecting the electrical wiring	8
10.2.1	To connect the electrical wiring	8
10.3	Closing the controller	9
10.3.1	To close the controller	9
11	Starting up the system	9
11.1	To designate a controller as slave	9
12	Maintenance	9
12.1	Maintenance safety precautions	9
12.2	To clean the controller	9
12.3	Time to clean filter indication	9
12.3.1	To remove the Time to clean filter indication	9

1 General safety precautions

Please read these general safety precautions carefully before installing air conditioning equipment, and be sure to install the equipment correctly.

Failure to follow these instructions properly may result in property damage or personal injury, which may be serious depending on the circumstances.

1.1 For the user



INFORMATION

Also see the operation manual delivered with the outdoor and indoor unit.



WARNING

Do NOT play with the unit or its remote controller. Accidental operation by a child may result in impairment of bodily functions and harm health.



WARNING

To prevent electric shocks or fire:

- Do NOT operate the controller with wet hands.
- Do NOT disassemble the controller and touch interior parts. Contact your dealer.
- Do NOT modify or repair the controller. Contact your dealer.
- Do NOT relocate or reinstall the controller by yourself. Contact your dealer.



WARNING

Do NOT use flammable materials (e.g. hairspray or insecticide) near the controller.



NOTICE

To clean the controller, do NOT use organic solvents, such as paint thinner. **Possible consequence:** damage, electric shock, or fire.

1.2 For the installer

- The precautions described in this document cover very important topics, follow them carefully.



INFORMATION

This controller is an option and cannot be used standalone. Also see the installation and operation manual of the indoor and outdoor units.



NOTICE

Improper installation or attachment of equipment or accessories could result in electric shock, short-circuit, leaks, fire or other damage to the equipment. Only use accessories, optional equipment and spare parts made or approved by Daikin.



WARNING

All field wiring and components **MUST** be installed by a licensed electrician and **MUST** comply with the applicable legislation.



NOTICE

The remote controller **MUST** be mounted indoors.



NOTICE

When the controller is used as room thermostat, select an installation location where the average temperature in the room can be detected.

Do NOT install the controller in the following places:

- In places that are exposed to direct sunlight.
- In places that are near a heat source.
- In places that are affected by outside air or air draught due to e.g. door opening/closing.

2 About this document

- In places where the display can easily get dirty.
- In places where there is NO easy access to the controls.
- In places with temperatures $\leq -10^{\circ}\text{C}$ and $>50^{\circ}\text{C}$.
- In places where the relative humidity is $>95\%$.
- In places where there is machinery that emits electromagnetic waves. Electromagnetic waves may disturb the control system, and cause malfunction of the equipment.
- In places where it may be exposed to water, or in generally moist areas.

If you are NOT sure how to install or operate the unit, contact your dealer.

After finishing installation:

- Conduct a trial operation to check for faults.
- Explain the user how to operate the controller.
- Ask the user to store the manual for future reference.



INFORMATION

Consult your dealer regarding the relocation and reinstallation of the controller.

2 About this document

Target audience

Authorised installers + end users

Documentation set

This document is part of a documentation set. The complete set consists of:

- **Installation and operation manual:**
 - Installation instructions
 - Basic operation instructions
 - Format: Paper (in the box of the controller)
- **Installer and user reference guide:**
 - Extended installation and operation information
 - Format: Digital files on <http://www.daikineurope.com/support-and-manuals/product-information/>
- **Daikin Control Assistant in-app documentation:**
 - The controller only allows for basic settings and operation. Advanced settings and operation are performed via the Daikin Control Assistant app. For more information, see the app and its in-app documentation.
 - Format: App available from Google Play and the Apple Store

Latest revisions of the supplied documentation may be available on the regional Daikin website or via your dealer.

The original documentation is written in English. All other languages are translations.

Technical engineering data

- A **subset** of the latest technical data is available on the regional Daikin website (publicly accessible).
- The **full set** of latest technical data is available on the Daikin extranet (authentication required).

For the user

3 Buttons

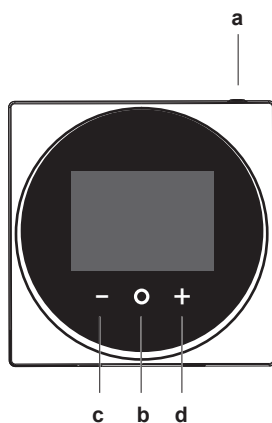

- a ON/OFF
Turn ON/OFF the system.
- b ENTER/ACTIVATE/SET
 - From the homescreen, enter the main menu.
 - From the main menu, enter one of the submenus.
 - From their respective submenu, activate an operation/ventilation mode.
 - In one of the submenus, confirm a setting.
- c CYCLE/ADJUST
 - Cycle left.
 - Adjust a setting (default: decrease).
- d CYCLE/ADJUST
 - Cycle right.
 - Adjust a setting (default: increase).

4 Home screens

Depending on installer configuration, your controller either has a standard or a detailed home screen. The standard home screen only displays the actual indoor temperature, messages (if any), the active operation mode, and the setpoint temperature (in case of Cooling, Heating, or Auto operation mode). The detailed home screen gives you all kinds of information through status icons.

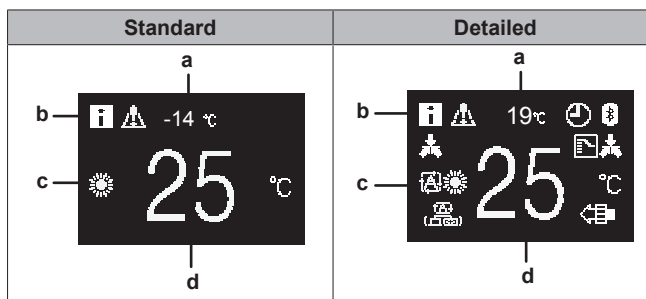

- a Actual indoor temperature
- b Messages
- c Active operation mode
- d Setpoint temperature

i INFORMATION

The controller is equipped with a power saving function that causes the screen to go blank after a period of inactivity. To make the screen light up again, press one of the buttons.

5 Status icons

Icon	Description
	Bluetooth. Indicates that the controller is communicating with a mobile device, for use with the Daikin Control Assistant app.
	Centralised control. Indicates that the system is controlled by central control equipment (optional accessory) and control of the system by this controller is NOT possible.
	Changeover under centralised control. Indicates that the cooling/heating changeover is under centralised control by another indoor unit, or by an optional cool/ heat selector that is connected to the outdoor unit.
	Defrost/Hot start. Indicates that the defrost/hot start mode is active.
	Timer. Indicates that the schedule timer or OFF timer is enabled.
	Self-cleaning filter. Indicates self-cleaning filter operation.
	Quick Start. Indicates that Quick Start mode is active (Sky Air only).
	Test operation. Indicates that Test Operation mode is active (Sky Air only).
	Inspection. Indicates that the indoor or outdoor unit is being inspected.
	Periodic inspection. Indicates that the indoor or outdoor unit is being inspected.
	Backup. Indicates that in the system an indoor unit is set as backup indoor unit.
	Airflow direction/swing. Indicates that the airflow direction or swing are set.
	Message. Indicates that the system has a message to convey. Enter the menu to see the message.
	Low noise operation/power consumption limitation/forced thermo off (BACnet). Indicates that the system is running under low noise operation, under power consumption limitation conditions, or receives a forced 'thermo off' command from a BACnet interface.
	Rotation. Indicates that Rotation mode is active.
	Setback. Indicates that the indoor unit is operating under setback control.

i INFORMATION

For information on the operation mode and ventilation mode icons, see "6.1 Operation mode" on page 5 and "6.4.1 Ventilation mode" on page 6 respectively.

6 Operation

From the home screen, press to enter the main menu. Use and to cycle through the menus. Press again to enter one of the menus.

i INFORMATION

- Depending on the type of indoor unit you are operating, more or less menus may be available.
- In the main menu, the icon for each menu reflects the current active setting or mode. When operating the controller, the menu you navigate through can look different from that represented in this manual.
- The controller only allows for basic operation of the system. For advanced operation (schedules, centralised control, ...), see the Daikin Control Assistant app.

6.1 Operation mode

The indoor unit can operate in various operation modes.

Icon	Operation mode
	Cooling. In this mode, cooling will be activated as required by the setpoint or limit operation.
	Heating. In this mode, heating will be activated as required by the setpoint or setback operation.
	Fan Only. In this mode, air circulates without heating or cooling.
	Dry. In this mode, the air humidity will be lowered with a minimal temperature decrease. The temperature and airflow level are controlled automatically and cannot be controlled by the controller. Dry operation will not function if the room temperature is too low.
	Ventilation. In this mode, the space gets ventilated, but not cooled or heated.
	Air Clean. In this mode, the optional air cleaning unit operates.
	Ventilation + Air Clean. Combination of ventilation and air clean operation.
	Auto. In Auto mode, the indoor unit automatically switches between heating and cooling mode, as required by the setpoint.

i INFORMATION

Depending on the indoor unit, more or less operation modes are available.

6.1.1 To set the operation mode

- Navigate to the operation mode menu.

6 Operation



- Use **-** and **+** to select an operation mode.



- Press **OK** to activate.

Result: The indoor unit changes its operation mode and the controller returns to the homescreen.

6.2 Setpoint

The setpoint is the target temperature for the Cooling, Heating, and Auto operation modes.

6.2.1 To set the setpoint

Prerequisite: The active operation mode is either 'Cooling', 'Heating', or 'Auto'.

- In the homescreen, use **-** and **+** to adjust the setpoint.



Result: The indoor unit changes its temperature setpoint.

6.3 Airflow

6.3.1 Airflow direction

The airflow direction is the direction in which the indoor unit blows its air. Depending on the indoor unit, the airflow direction can be set in a vertical orientation (flaps moving up/down) and/or a horizontal orientation (flaps moving left/right).

i INFORMATION

For more information, see the installer and user reference guide.

To set the airflow direction (vertical)

- Navigate to the airflow direction menu.



- Use **-** and **+** to adjust the airflow direction.



- Press **OK** to confirm.

Result: The indoor unit changes its airflow direction and the controller returns to the homescreen.

To set the airflow direction (horizontal)

- Navigate to the airflow direction menu.



- Use **-** and **+** to adjust the airflow direction.



- Press **OK** to confirm.

Result: The indoor unit changes its airflow direction and the controller returns to the homescreen.

6.3.2 Airflow level

The airflow level is the strength of the airflow coming out of the indoor unit.

i INFORMATION

For more information, see the installer and user reference guide.

To set the airflow level

- Navigate to the airflow level menu.



- Use **-** and **+** to adjust the airflow level.



- Press **OK** to confirm.

Result: The indoor unit changes its airflow level and the controller returns to the homescreen.

6.4 Ventilation



i INFORMATION

Ventilation settings can ONLY be made for Heat Reclaim Ventilation units.

6.4.1 Ventilation mode

The Heat Reclaim Ventilation unit can operate in various operation modes.

Icon	Ventilation mode
	Energy Reclaim Ventilation. The outdoor air is supplied to the room after passing through a heat exchanger.

Icon	Ventilation mode
	Bypass. The outdoor air is supplied to the room without passing through a heat exchanger.
	Auto. To ventilate the room in the most efficient way, the Heat Reclaim Ventilation unit automatically switches between "Bypass" and "Energy Reclaim Ventilation" mode (based on internal calculations).



INFORMATION

Depending on the Heat Reclaim Ventilation unit, more or less ventilation modes are available.

To set the ventilation mode

- 1 Navigate to the ventilation mode menu.

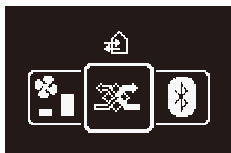

- 2 Use  and  to select a ventilation mode.

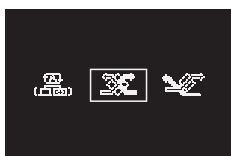

- 3 Press  to activate.

Result: The Heat Reclaim Ventilation unit changes its operation mode and the controller returns to the homescreen.

6.4.2 Ventilation rate

The ventilation rate is the strength of the ventilation operation.

To set the ventilation rate

- 1 Navigate to the ventilation rate menu.

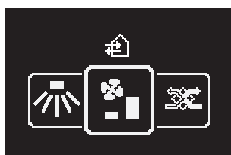

- 2 Use  and  to adjust the ventilation rate.

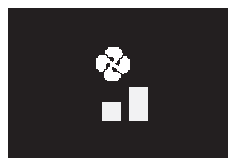

- 3 Press  to confirm.

Result: The Heat Reclaim Ventilation unit changes its ventilation rate and the controller returns to the homescreen.

6.5 Advanced operation



The controller only allows for basic operation. For advanced operation, use the Daikin Control Assistant app. Before you can use the app, you first have to make a Bluetooth connection between the controller and the mobile device on which the app is installed.

6.5.1 To make a Bluetooth connection

Prerequisite: You have a mobile device on which the Daikin Control Assistant app is installed and running.

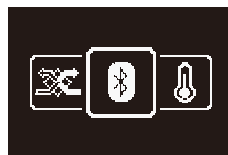
- 1 Navigate to the Bluetooth menu.



- 2 Use  to activate  and make the controller send out a Bluetooth signal.

Result: Your mobile device connects to the controller and the app takes over the rest of the connection.



Result: You can now use the app for advanced operation.

7 Maintenance and service

7.1 Overview: Maintenance

When the filter is dirty, the system is in error, or the indoor unit needs to be maintained otherwise, consult your dealer.

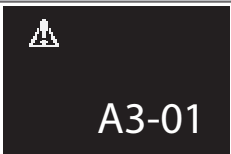
To indicate this, you will be confronted by an error or maintenance screen upon trying to enter the main menu.

Error screen (example)	Maintenance screen (example)
	

For the installer

8 About the box

8.1 To unpack the controller

- 1 Open the box.
- 2 Separate the accessories.

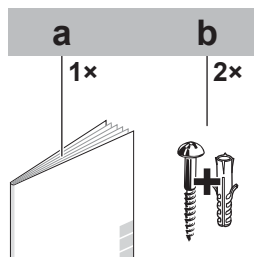

9 Preparation

- a Installation and operation manual
- b Wood screws + wall plugs (Ø4.0×30)

9 Preparation

9.1 Wiring requirements

All wiring must comply with the following requirements:

Wire specification	Value
Type	Sheathed vinyl cord or cable (2 wires)
Section	0.75~1.25 mm ²
Maximum length	500 m

To prepare the wiring for installation:

- 1 Peel the sheath of the part of the cable that needs to pass through the inside of the rear casing (L), according to the figure and the table.
- 2 Keep a 10 mm distance between the length of the 2 wires.

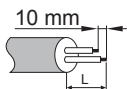

Wiring outlet	L
Top outlet	±150 mm
Top center outlet	±200 mm

10 Installation

10.1 Mounting the controller

Before you can mount the controller, you have to determine the wiring routing, and accordingly, remove a piece of the controller's rear casing.

The wiring can be routed from the top, the rear, the left, or the bottom. Remove a piece of the rear casing according to the illustration:

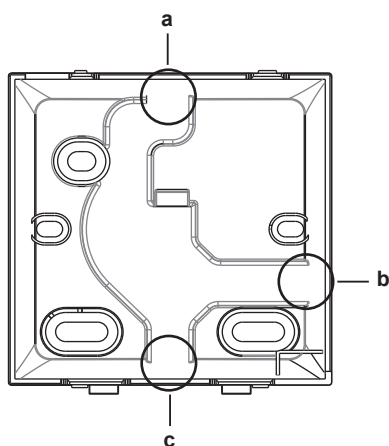

- a Wiring from the top
- b Wiring from the left
- c Wiring from the bottom

In case you are routing the wiring from the rear, you don't have to remove anything.

10.1.1 To mount the controller

- 1 Take the screws and plugs from the accessory bag.

- 2 Mount the rear casing to a flat surface.

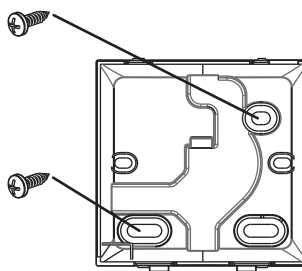

NOTICE

Be careful not to distort the rear casing by overtightening the mounting screws.

10.2 Connecting the electrical wiring



NOTICE

The wiring for connection is NOT included.



NOTICE

When wiring, run the wiring away from the power supply wiring in order to avoid receiving electric noise (external noise).

10.2.1 To connect the electrical wiring

Connect controller terminals P1/P2 to indoor unit terminals P1/P2.

From the top

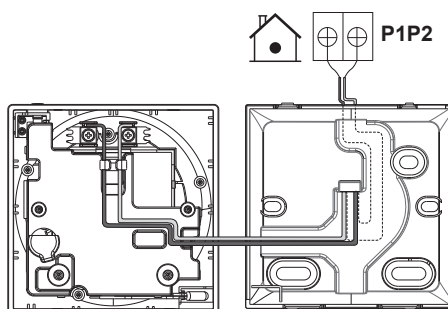

From the rear

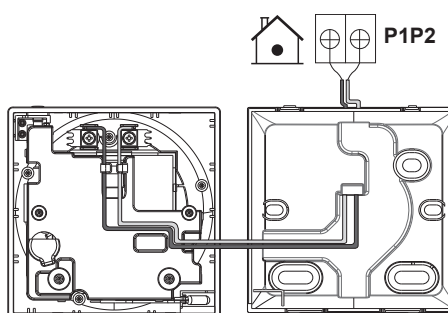

11 Starting up the system

From the left

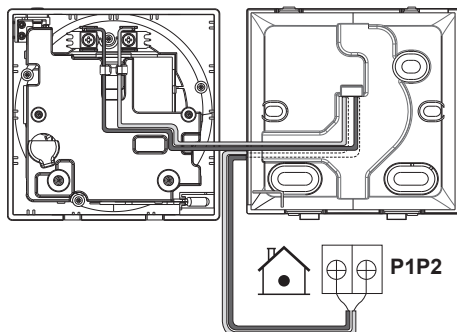

From the bottom

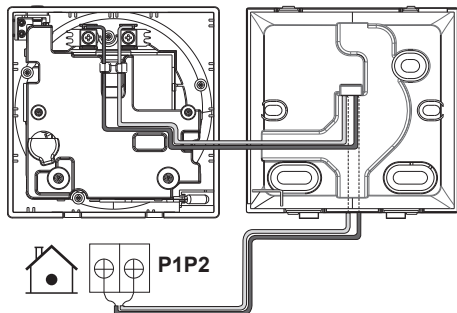

10.3 Closing the controller



CAUTION

Never touch the internal parts of the controller.



CAUTION

When closing the controller, be careful not to pinch the wiring.



NOTICE

To prevent damage, make sure the front of the controller is clicked into the rear casing securely.

10.3.1 To close the controller

- 1 Click the front of the controller into the rear casing.

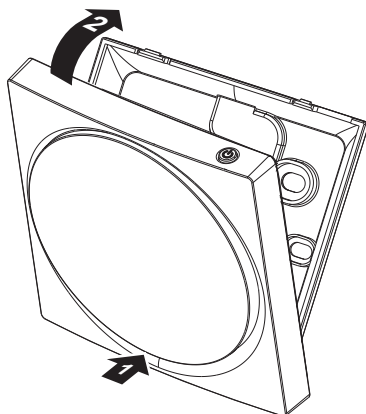

11 Starting up the system

The controller gets its power from the indoor unit. It will start up as soon as it is connected. For the controller to be operable, therefore make sure the indoor unit is powered on.

Once the controller is powered, it will automatically start up. If it is the first and only controller that is connected to the indoor unit, it will automatically get designated as master controller. For a second controller to get designated as slave controller, manual action is required.

11.1 To designate a controller as slave

Prerequisite: A master controller is already connected to the indoor unit.

- 1 Connect a second controller.
Result: It will start up automatically.
- 2 Wait for a U5 or U8 error to appear on the screen.
- 3 When the U5 or U8 error appears, press  and keep it pressed until "2" appears on the screen.

Result: The controller is now designated as slave.

12 Maintenance

12.1 Maintenance safety precautions



WARNING

Before carrying out any maintenance or repair activities, stop system operation with the controller, and turn off the power supply circuit breaker. **Possible consequence:** electric shock or injury.



NOTICE

To clean the controller, do NOT use organic solvents, such as paint thinner. **Possible consequence:** damage, electric shock, or fire.



WARNING

Do not wash the remote controller. **Possible consequence:** electric leakage, electric shock, or fire.

12.2 To clean the controller

- 1 Wipe the screen and other surface parts of the controller with a dry cloth.



INFORMATION

If the dirt on the surface cannot be removed, soak the cloth in neutral detergent diluted with water, squeeze the cloth tightly, and clean the surface. Afterwards, wipe dry with a dry cloth.

12.3 Time to clean filter indication

When the indoor unit filter is dirty and needs to be cleaned, the controller will indicate this by displaying  in the top right corner of the home screen, and confronting you with the 'Time to clean filter' screen as soon as you try to enter the main menu from the home screen.

12.3.1 To remove the Time to clean filter indication

Prerequisite: On trying to enter the main menu from the home screen, you are confronted with the 'Time to clean filter' screen.

12 Maintenance

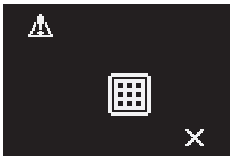

- 1 Clean the filter.
- 2 Press **+** to remove the 'Time to clean filter' indication.

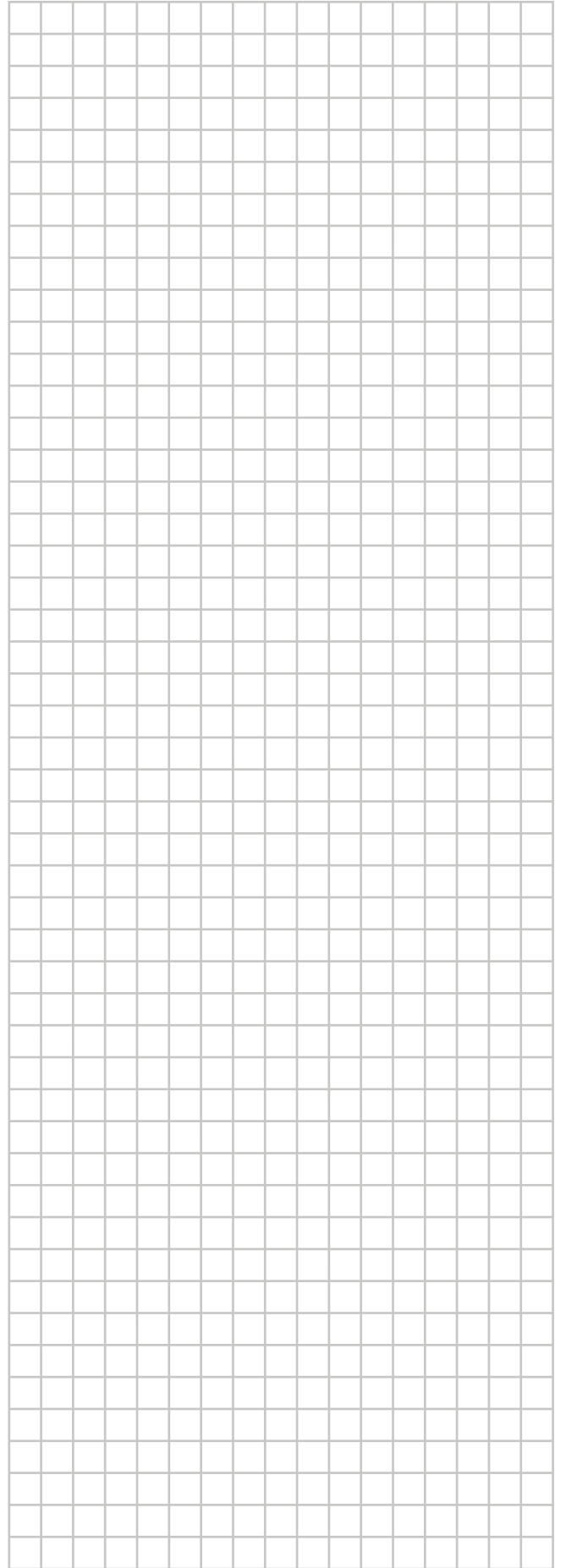
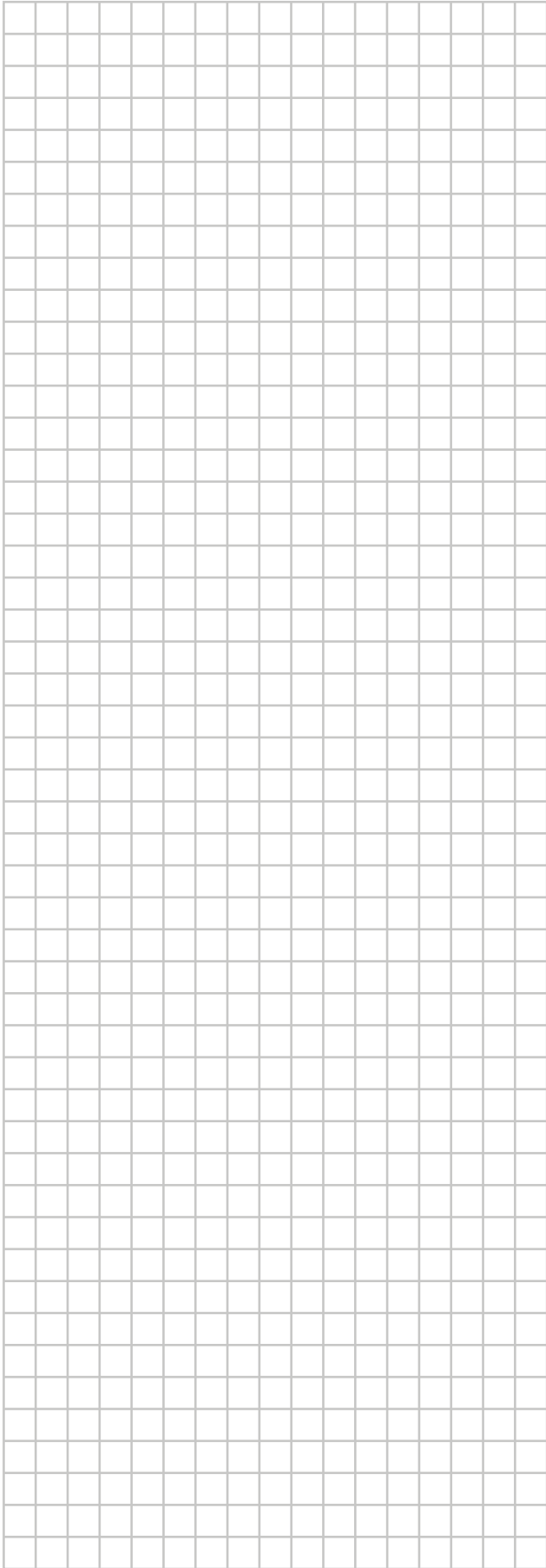

ERC

Copyright 2017 Daikin

DAIKIN EUROPE N.V.

Zandvoordestraat 300, B-8400 Oostende, Belgium

4P511630-1 2017.10